

Инструкция по сборке мебели
Instructions for furniture assembling

Кровать базовой комплектации
Bed of basic configuration

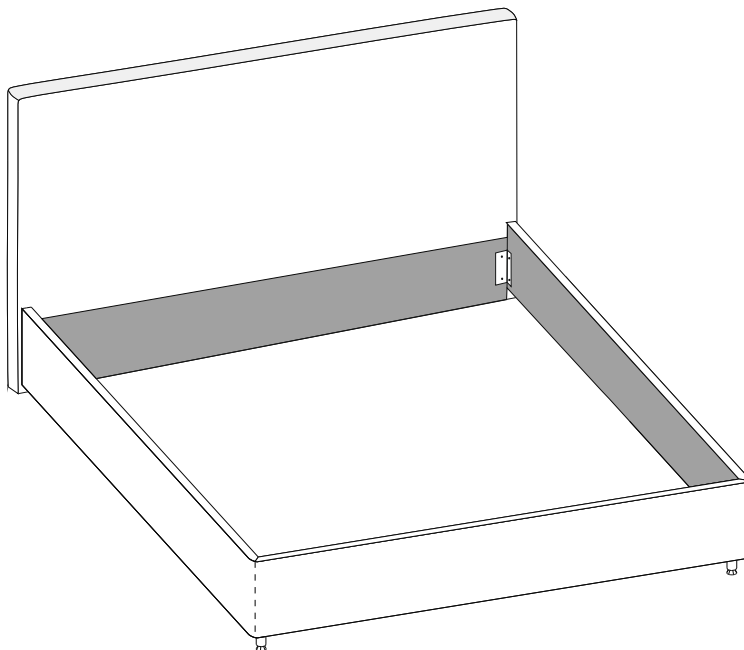









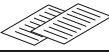
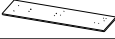

*модель царг указана на этикетке изделия
*side bars model is indicate on the product label

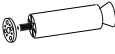

Изготовитель: ООО «Литвуд»
Кровать соответствует ТР ТС 025/2012, Гост 19917-2014
Manufacturer «Litwood» Ltd.
The bed is in full compliance with GOST (Russian National Standart) 19917-2014

Комплектовочная ведомость кровати

Упаковка	Деталь	Артикул	Наименование	Количество
Упаковка №1		K01	Спинка	1
		K09	Чехол на царги (*для кроватей со съемным чехлом и царгами, полностью обитыми технической тканью)	1
			Инструкция по эксплуатации (паспорт)	1
Упаковка №2		K02	Боковая царга	2
		K03	Средняя царга	1
			Образец ткани (*вшит в чехол или в царгу)	1
Упаковка №2 Пакет с фурнитурой			Инструкция по сборке	1
		KФ01	Винт М6*20	20
		KФ23	Уголок царг	2
		KФ22	Уголок спинки	2
			Ножки Модификация ножек зависит от модели кровати, представленной в качестве образца в салоне или на сайте. (см. комплектовочную ведомость ножек)	1 компл
Упаковка №3		P01	Кроватное основание	1













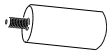











Модификация ножек зависит от модели кровати, представленной в качестве образца в салоне или на сайте.

***Вид комплектации отражен на этикетке пакета с фурнитурой**













Комплектовочная ведомость ножек

Упаковка	Деталь	Артикул	Наименование	Количество
Вариант комплектации ножек №1		KФ54	Ножка для кроватей №1156 хром h-150 (шп. 8мм)	2
		KФ39	Гайка M8	2
		KФ40	Шайба M8	2
Вариант комплектации ножек №2		KФ31	Ножка деревянная h-97 угловая	2
		KФ39	Гайка M8	2
		KФ81	Подпятник самокл. фетр 20*20	4

Комплектовочная ведомость ножек

Упаковка	Деталь	Артикул	Наименование	Количество
Вариант комплектации ножек №3		КФ45	Ножка для кроватей h-60 венге (M10)	2
		КФ46	Гайка декоративная	2
		КФ81	Подпятник войлочный 20x20	2
Вариант комплектации ножек №4		КФ41	Опора декоративная h-130 хром	2
		КФ43	Винт M8x20 DIN 967	2
		КФ42	Шайба M8	2
		КФ39	Гайка M8	2
		КФ81	Подпятник войлочный 20x20	2
Вариант комплектации ножек №5		КФ55	Ножка для кроватей 178 h-50 хром	2
		КФ39	Гайка M8	2
		КФ40	Шайба M8	2
Вариант комплектации ножек №6		КФ69	Ножка для кроватей h-120	2
		КФ37	Гайка декоративная	2
Вариант комплектации ножек №7		КФ77	Ножка для кроватей h-100 хром	2
		КФ39	Гайка M8	2
		КФ40	Шайба M8	2
Вариант комплектации ножек №8		КФ140	Опора конусная 60*60*195 шпилька M8	2
		КФ144	Гайка M8	2
		КФ81	Подпятник войлочный 20x20	2
Вариант комплектации ножек №9		КФ130	Опора конусная 60*45*120 шпилька M8	2
		КФ144	Гайка M8	2
		КФ81	Подпятник войлочный 20x20	2

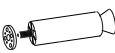





Packing List of the bed

Package	Part	Part number	Name	Quantity
Package №1		K01	Backrest	1
		K09	Cover for side bars (*for beds with removable cover and side bars completely upholstered with technical fabric)	1
			Instructions for use (certificate)	1
Package №2		K02	Lateral side bar	2
		K03	Intermediate side bar	1
			Fabric sample (sewn in the cover or the side bar)	1
Package №2 Accessories pack			Assembly instructions	1
		KF01	Screw M6*20	20
		KF23	Side bars angle piece	2
		KF22	Backrest angle piece	2
			Legs Legs variant depends on a bed model that is represented as a sample in showroom or on the website. (See Legs Delivery list)	1 set
Package №3		R01	Bed base	1











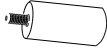













**Legs variant depends on bed model that is represented as a sample in showroom or on the website.
Complete set is shown on the label of Accessories Pack**

Packing set for legs

Package	Part	Part number	Name	Quantity
Legs complete set №1		KF54	Leg for beds №1156 chrome h-150 (pin 8mm)	2
		KF39	Nut M8	2
		Kf40	Washer M8	2
Legs complete set №2		KF31	Leg wooden h-97 corner	2
		KF39	Nut M8	2
		KF81	Glide self-adhesive felt 20x20	4

Packing set for legs

Package	Part	Part number	Name	Quantity
Legs complete set №3		KF45	Leg for beds h-60 venge (M10)	2
		KF46	Decorative nut	2
		KF81	Glide felted 20x20	2
Legs complete set №4		KF41	Leg decorative h-130 chrome	2
		KF43	Screw M8x20 DIN 967	2
		KF42	Washer M8	2
		KF39	Nut M8	2
		KF81	Glide felted 20x20	2
Legs complete set №5		KF55	Leg for beds 178 h-50 chrome	2
		KF39	Nut M8	2
		KF40	Washer M8	2
Legs complete set №6		KF69	Leg for beds h-120	2
		KF37	Decorative nut	2
Legs complete set №7		KF77	Leg for beds h-100 chrome	2
		KF39	Nut M8	2
		KF40	Washer M8	2
Legs complete set №8		KF140	Leg conical 60*60*195 pin M8	2
		KF144	Nut M8	2
		KF81	Glide felted 20x20	2
Legs complete set №9		KF130	Leg conical 60*45*120 pin M8	2
		KF144	Nut M8	2
		KF81	Glide felted 20x20	2





Перед сборкой:

- 1. Все детали осмотреть до сборки на отсутствие повреждений.** Претензии по ним на собранном изделии не удовлетворяются изготовителем. Упаковку необходимо сохранять до окончания сборки.
- 2. При выявлении в процессе сборки брака и некомплектности изделия необходимо сохранять упаковку до момента выезда представителя торговой компании.** Инструкции по сборке и эксплуатации изделия необходимо сохранять на весь период эксплуатации.
- 3. Проверьте количество деталей и фурнитуры по перечню.** Предприятие-изготовитель оставляет за собой право вносить конструктивные изменения в изделие, заменять фурнитуру и метизы на аналогичные, не ухудшающие внешний вид и не влияющие на функциональные свойства изделия. При недокомплекте или поломке, обведите номер отсутствующей детали и сообщите в магазин для ее замены.
- 4. Соблюдайте порядок сборки, данный в этой инструкции!**
При несоблюдении инструкций по сборке и эксплуатации с компании-производителя снимаются гарантийные обязательства.
- 5. Для установки дивана/кресла-кровати/кровати выбирайте ровный участок пола!**
При искривлениях пола возможны отклонения в работе механизма трансформации дивана/кресла-кровати, перекосы формы изделия. Нежелательно наличие ковра, так как это затрудняет трансформацию.
- 6. Проводите сборку дивана/кресла-кровати/кровати вдвоём.**
Перемещайте все детали бережно, без рывков, укладывайте устойчиво, избегайте их падений и ударов!
- 7. Передвигайте мебель и ее детали, только слегка приподнимая.** Это позволит исключить деформации и поломки.

Prior to assembly:

- 1. Check all the parts for any damage before assembling.** Any claim for them on assembled article is not accepted by Manufacturer. Package shall be kept until the end of assembly process.
- 2. When revealing any defect or incompleteness in the process of assembling, the package shall be kept until a representative of trading company arrives.** Assembly and operation Instructions shall be kept during all the period of exploitation.
- 3. Check the parts and accessories quantity against the list.** Manufacturer retains the right to make structural changes into the article, change accessories and metalware for analogous that do not affect design and do not influence on functional properties of the article. If incompleteness or any damage, mark absent part number and inform the store to replace it.
- 4. Maintain the assembly order given in these instructions!** If the Assembly and Operation Instructions are not followed the manufacturer's warranty obligations are removed.
- 5. To install sofa/armchair-bed/bed a flat floor zone shall be chosen!** If the floor are curved may present deviations in the functioning of transformation mechanism of sofa/armchair-bed/bed, distortions of the article form. Any carpet presence is undesirable, because it makes transformation process difficult.
- 6. Perform the sofa/armchair-bed/bed assembly by two.** Move all the parts gently without any jump, place them steady, escape their falls and hits!
- 7. Move furniture and their parts only slightly lifted.** This will allow to exclude any deformation or damage.

Для сборки понадобятся/ For assembling required

			
Крестовая отвертка Cross-point screwdriver	Рожковый ключ №13 Open-end wrench №13	Ножницы Scissors	Рулетка Tape-measure

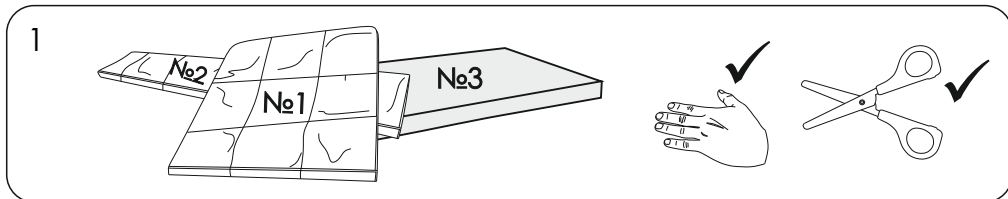

Инструкция по сборке мебели. Кровать базовой комплектации. Версия 20 от 06.05.2024. Для царг типа:
Instructions for furniture assembling. Bed of basic configuration. Version 20 from 06.05.2024.
For side bars types: 10, 10-R, 30-D, 50, 50-D, 50-P, 80, 90, 90-M Grand, 90-V, 120-АФ, 140, 180, 250

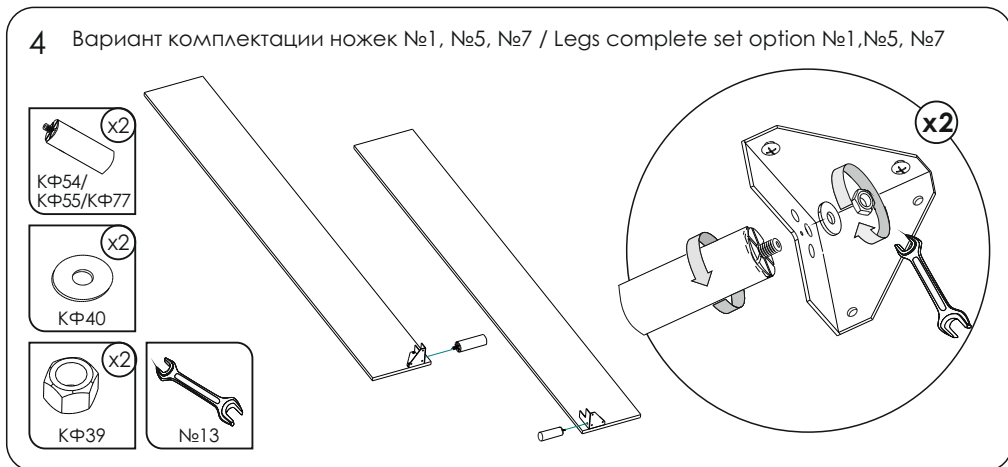
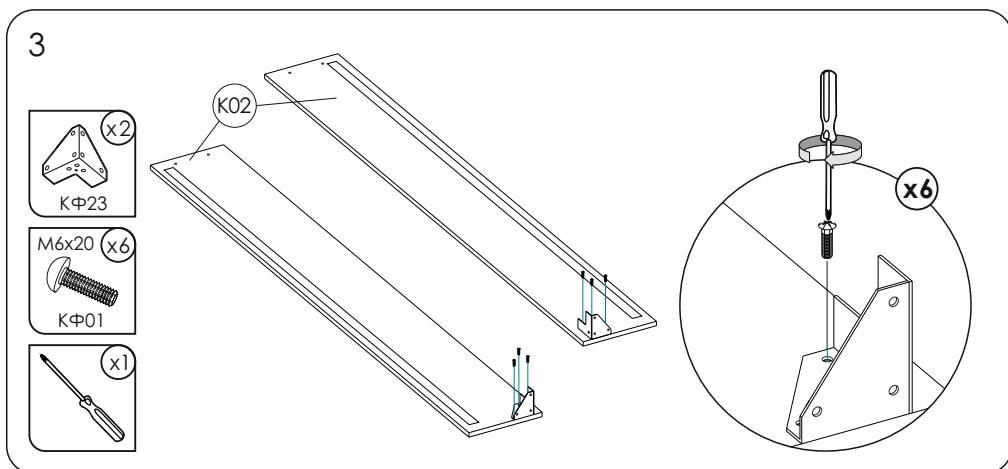
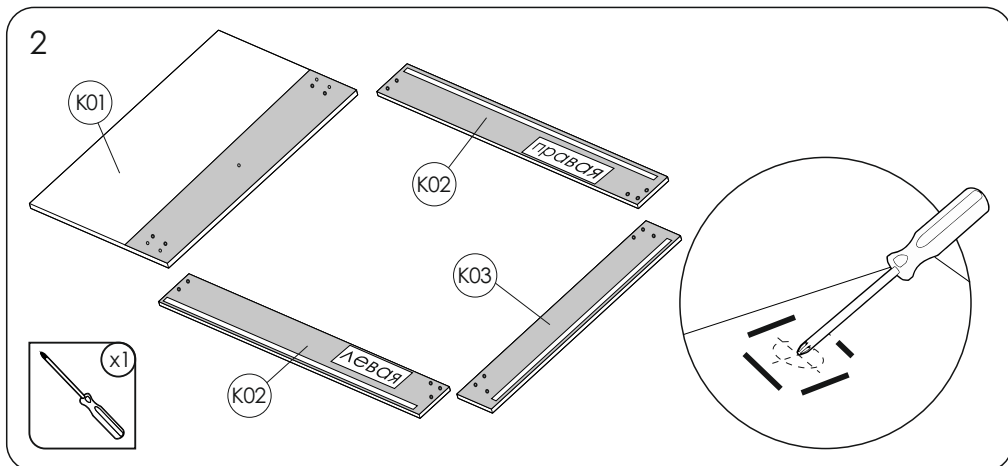

5

Вариант комплектации ножек №2 (h-97 угловая) /
 Legs complete set option №2 (h-97 corner)

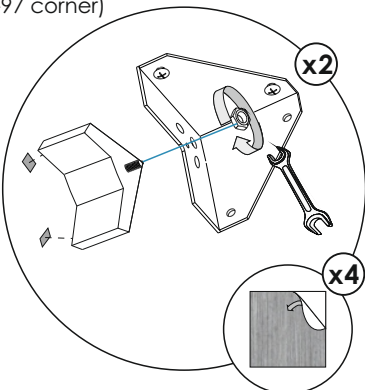
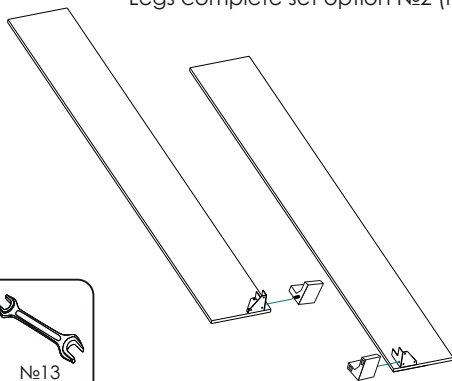
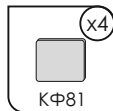
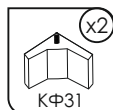

6

Вариант комплектации ножек №3 (h-60 венге) /
 Legs complete set option №3 (h-60 venge)

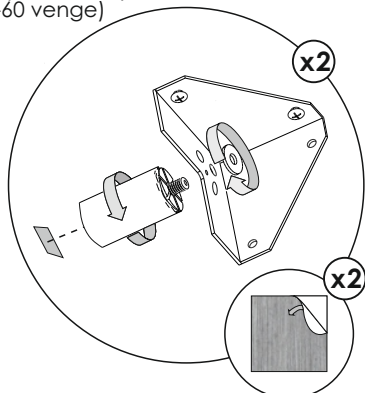
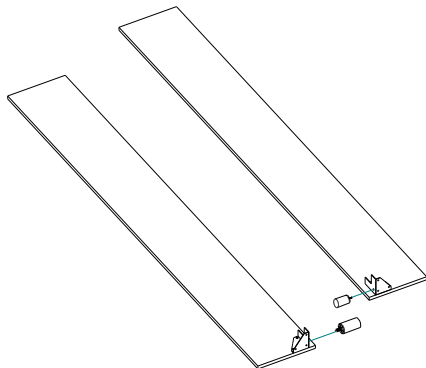
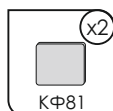
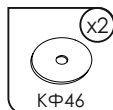
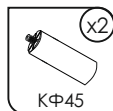

7

Вариант комплектации ножек №4 (h-130 хром) /
 Legs complete set option №4 (h-130 chrome)

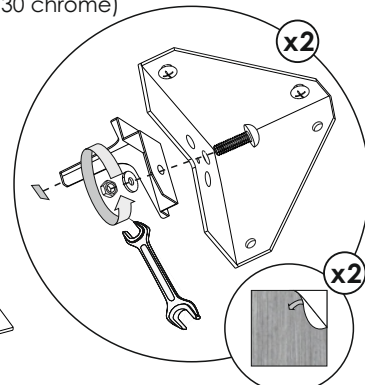
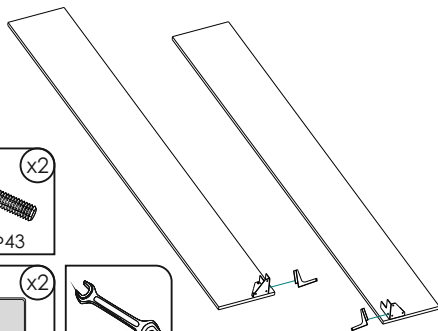
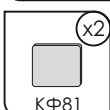
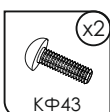
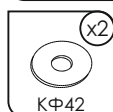
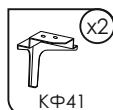

8 Вариант комплектации ножек №6 (h-120) / Legs complete set option №6 (h-120)

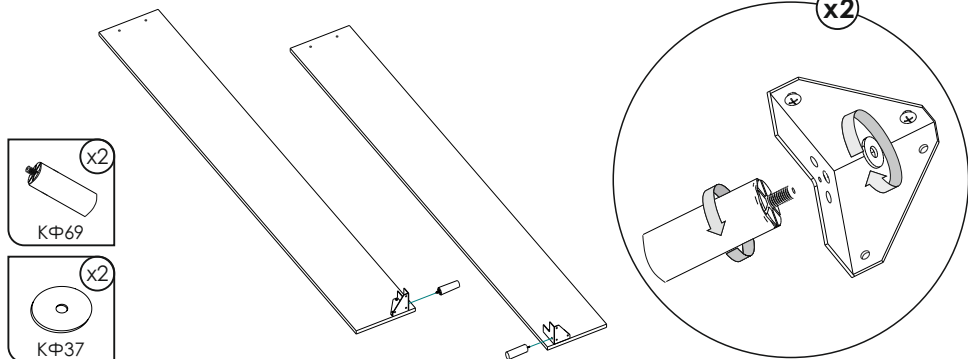

9 Вариант комплектации ножек №8, №9 / Legs complete set option №8, №9

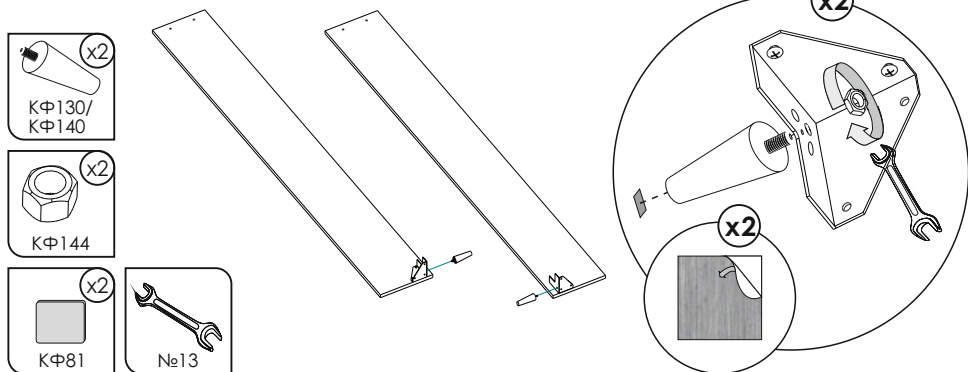

10

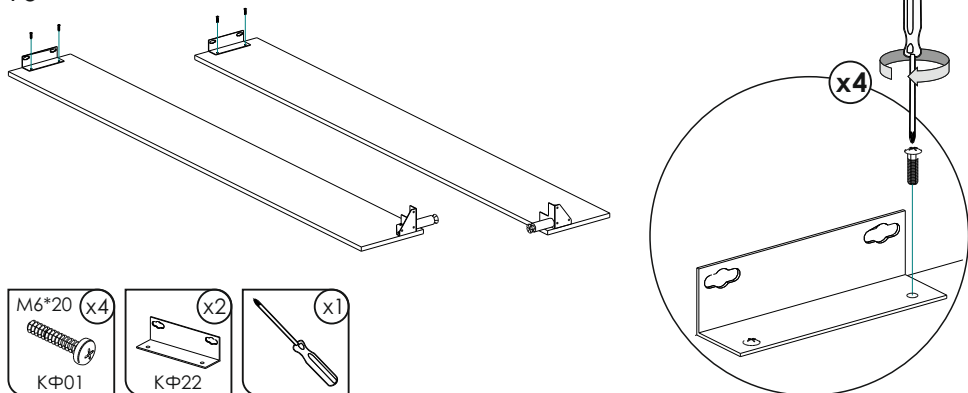

11

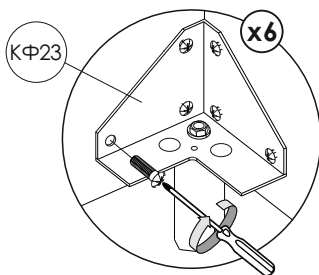
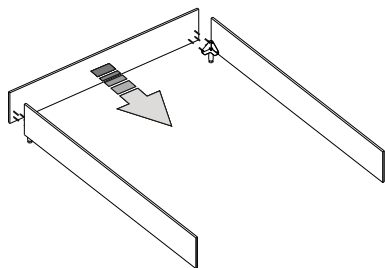
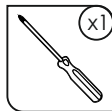
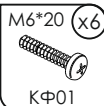

12 Установка чехла на царги, перед креплением спинки производится только для кроватей с «ушами»
Cover for side bars installation before the backrest attachment is carried out only for beds with «ears»

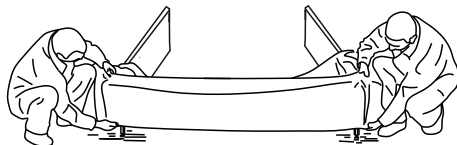
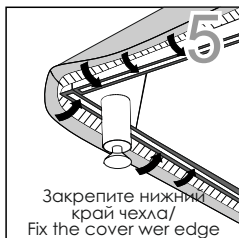
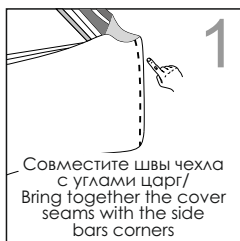
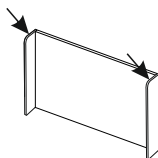

13

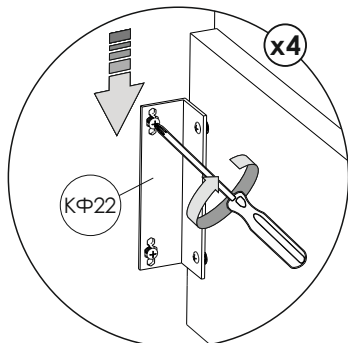
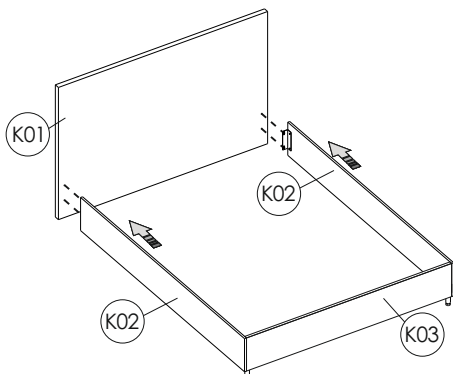
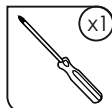
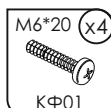

14

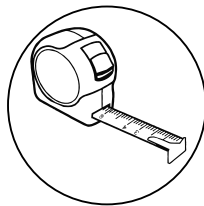
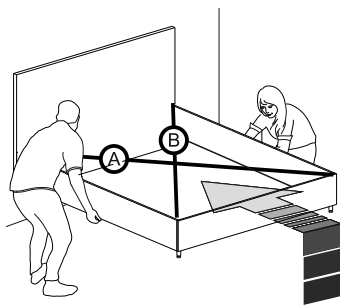

 $A \approx B$

После регулировки периметра затянуть винты/
After the perimeter adjustment tighten the screws

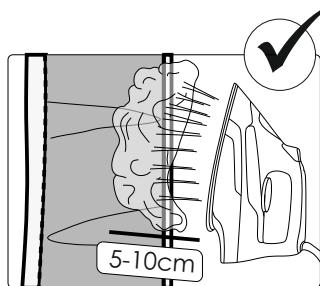
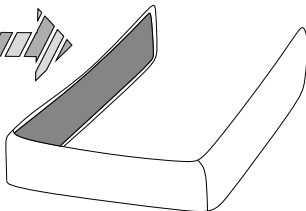
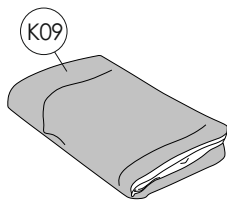
15

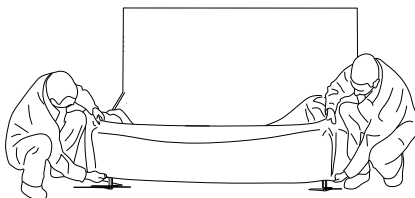
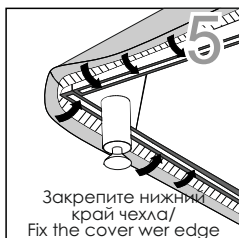

16 Только для кроватей со съемным чехлом и царгами, полностью обитыми технической тканью
Only for beds with removable cover and side bars completely upholstered with technical fabric



17

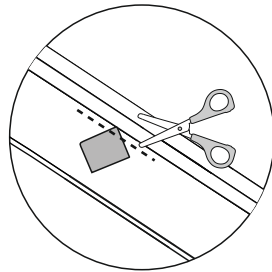
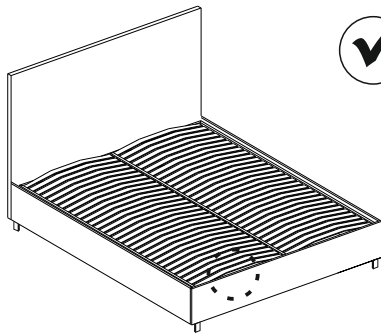

В случае необходимости образец материала может быть отрезан либо
заправлен под съёмный чехол
If necessary material sample may be cut off or put under removable cover

18

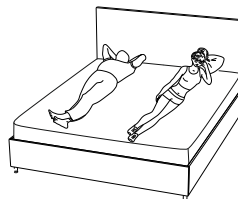
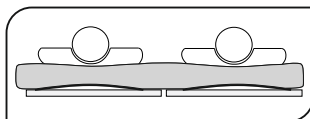
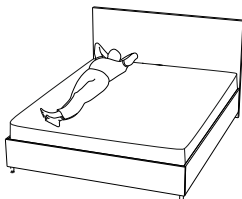
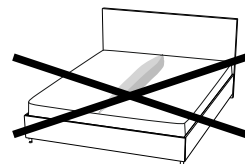
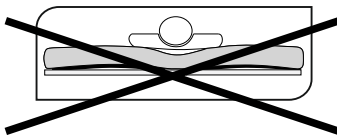
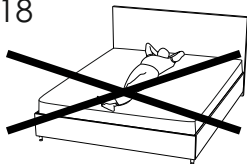

19

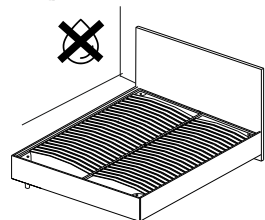
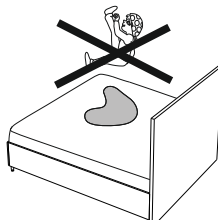
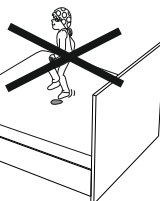
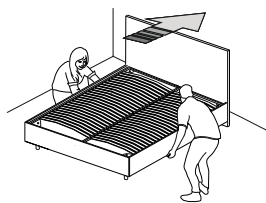
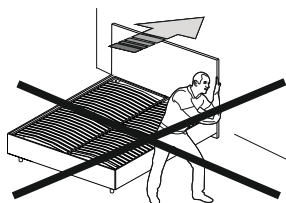

Инструкция по сборке мебели. Кровать базовой комплектации. Версия 20 от 06.05.2024. Для царг типа:
Instructions for furniture assembling. Bed of basic configuration. Version 20 from 06.05.2024.
For side bars types: 10, 10-R, 30-D, 50, 50-D, 50-P, 80, 90, 90-M Grand, 90-V, 120-АФ, 140, 180, 250