

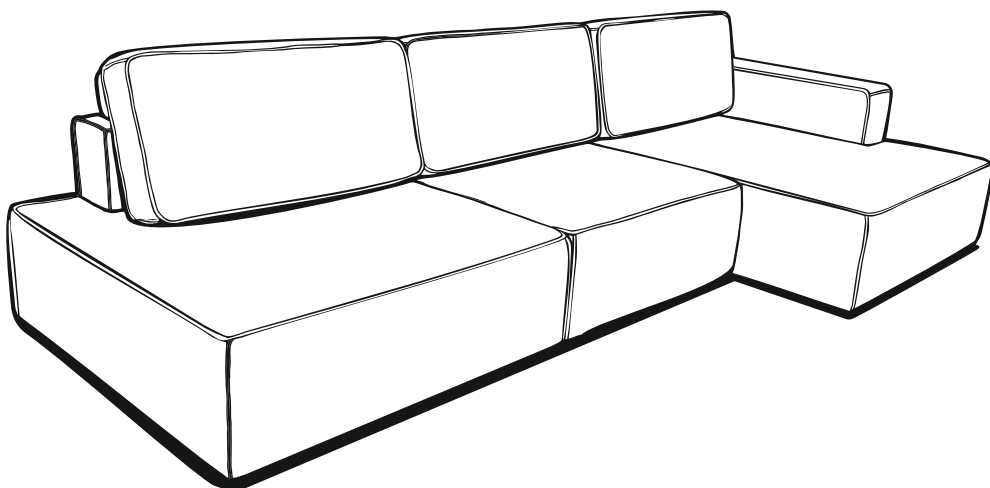

Инструкция по
сборке мебели
Диван-кровать Ральф

Instruction on
Assembling Furniture
Sofa-bed Ralf



TP TC 025/2012

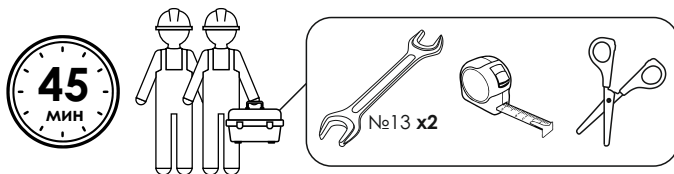

Центральная секция / Боковая секция
Секция канapé
Central section / Side section / Canapé section

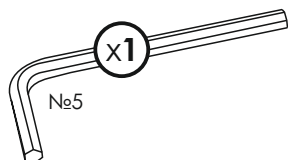
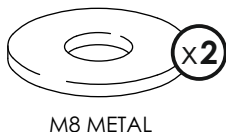
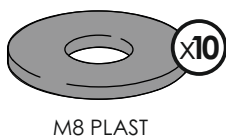
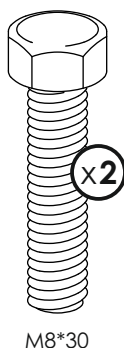
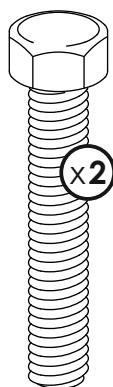
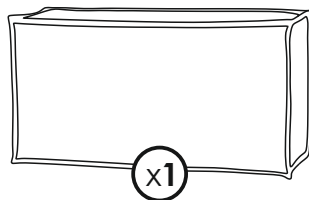
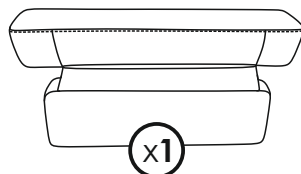
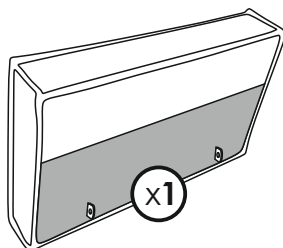
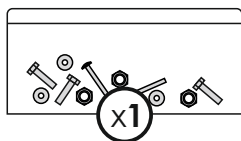
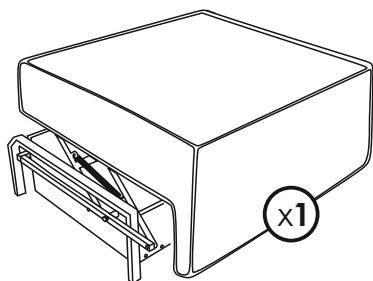

ПОДЛОКОТНИК Armrest

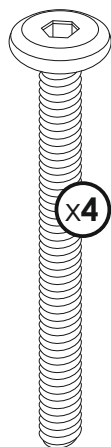
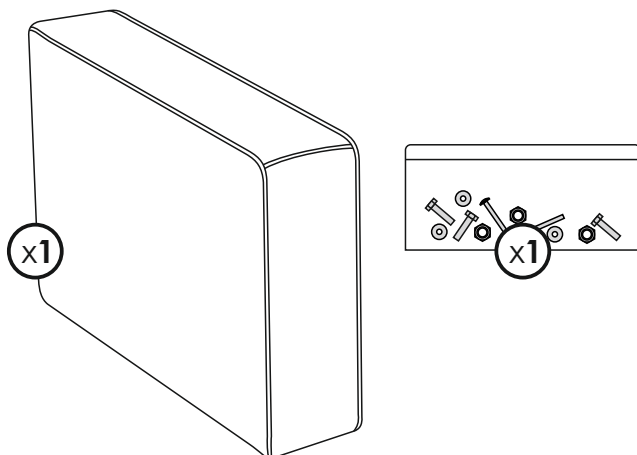

M6*55
DIN 7420

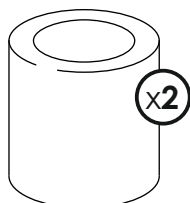

d 20x20
PLAST

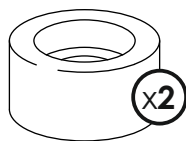

d 20x10
PLAST

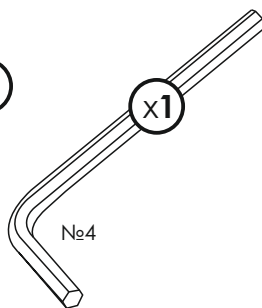

№4

Схема сборки дивана RALF Assembly Diagram of Sofa-bed RALF

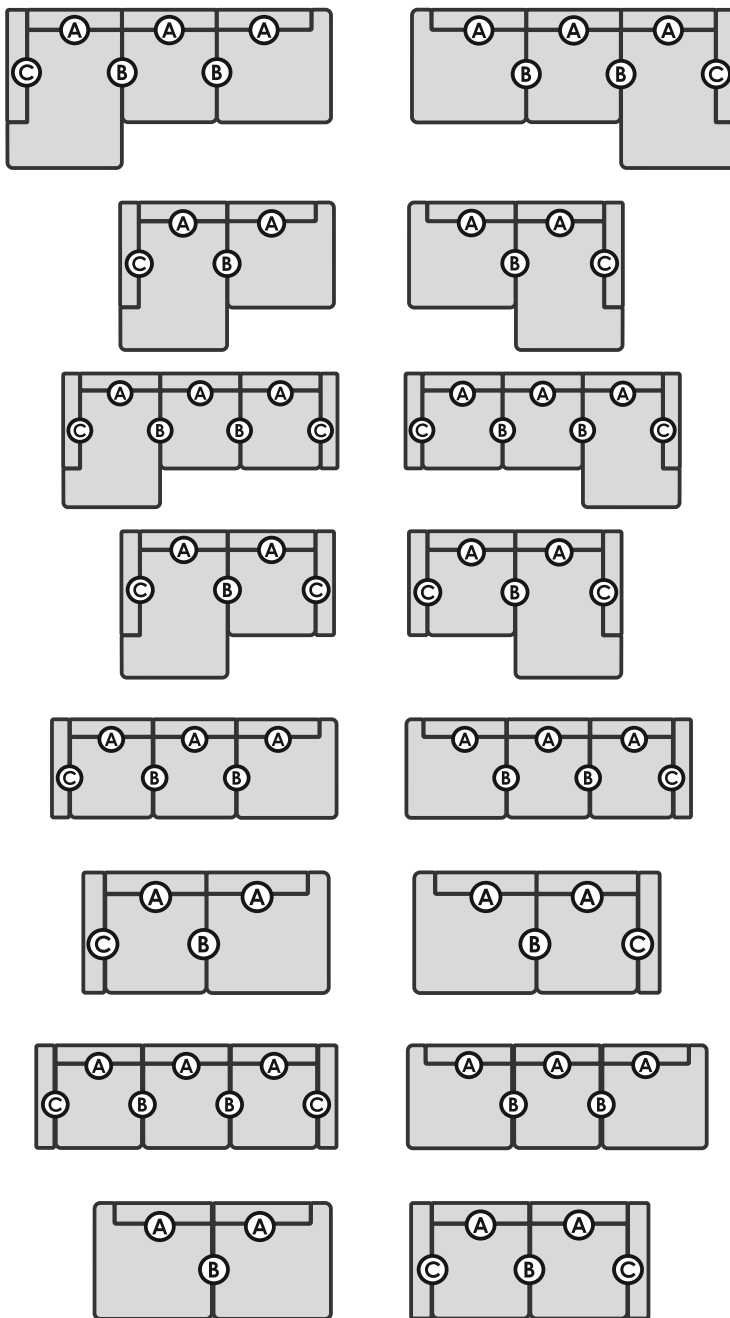

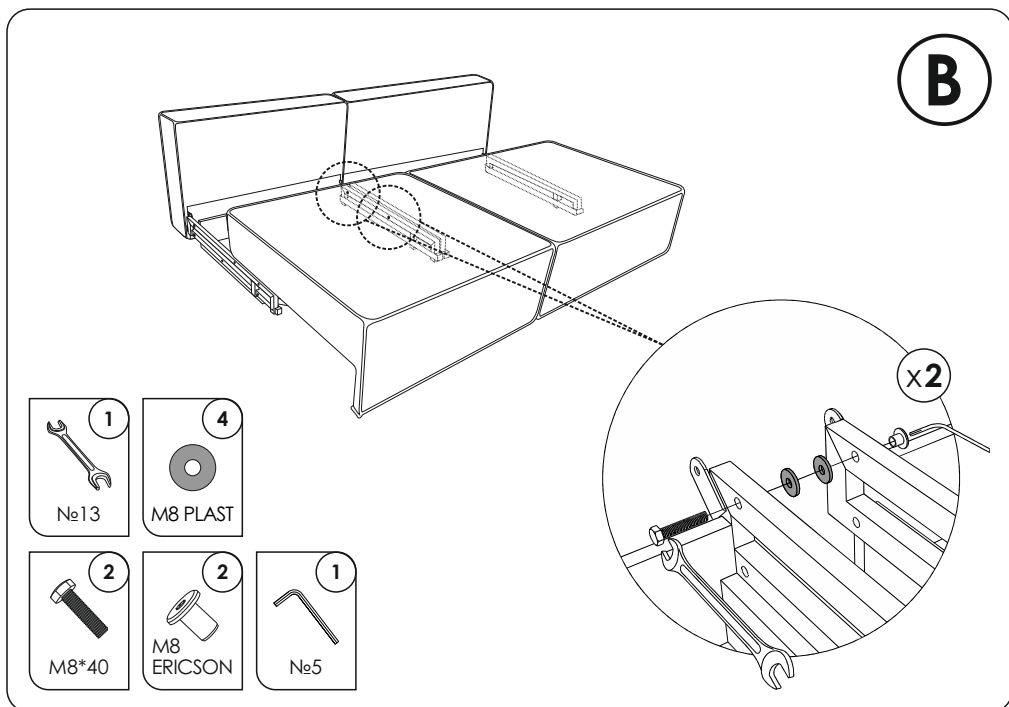
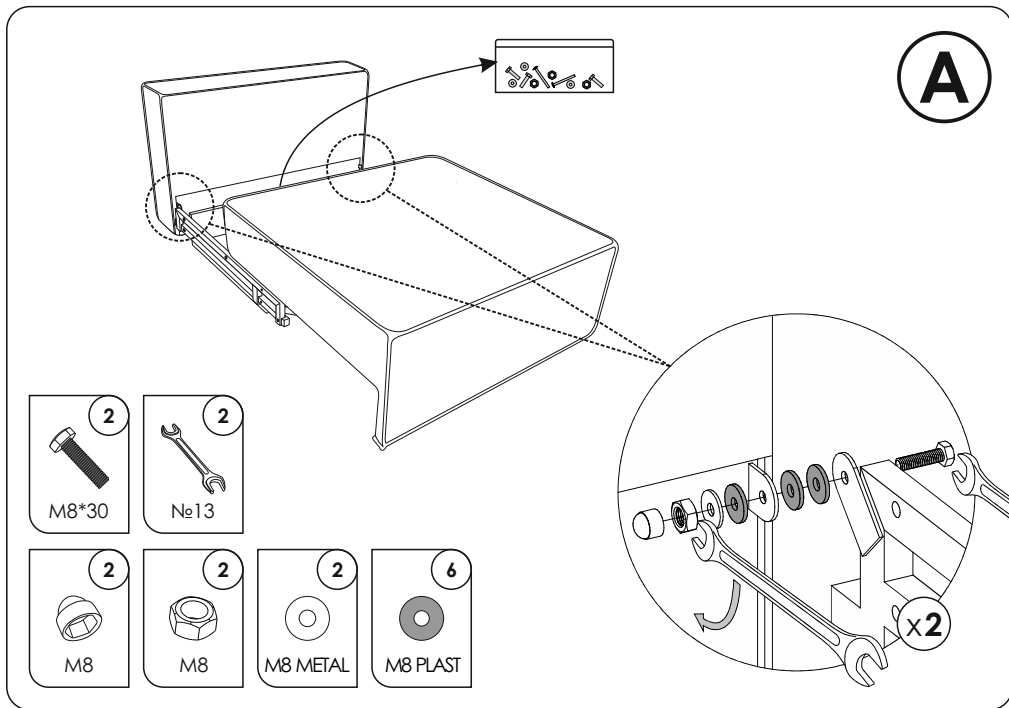

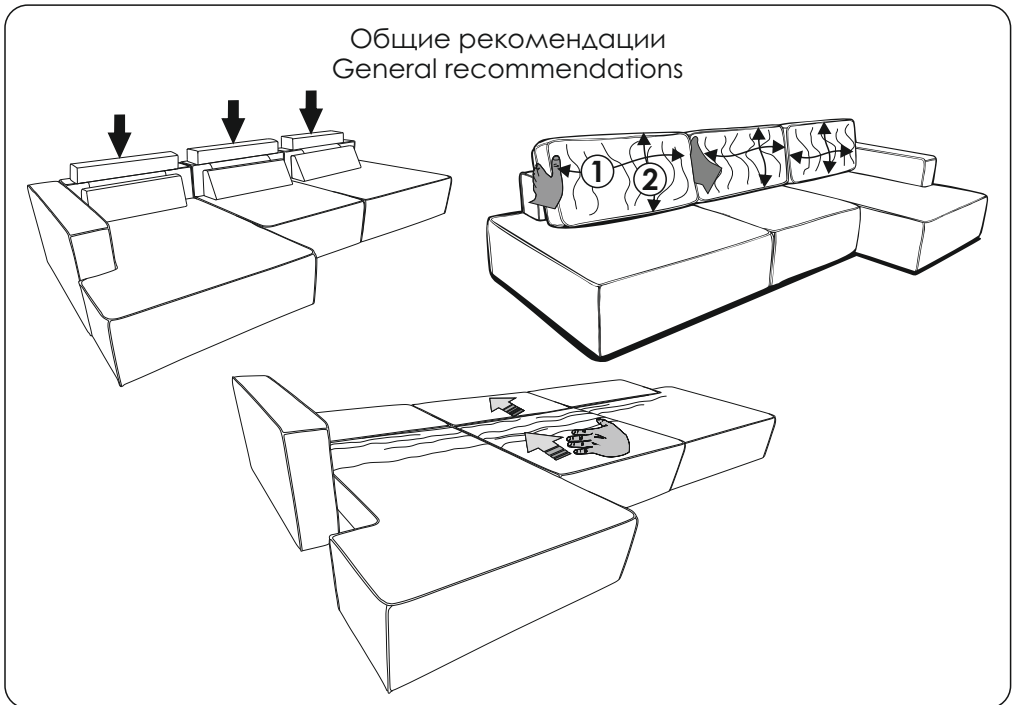
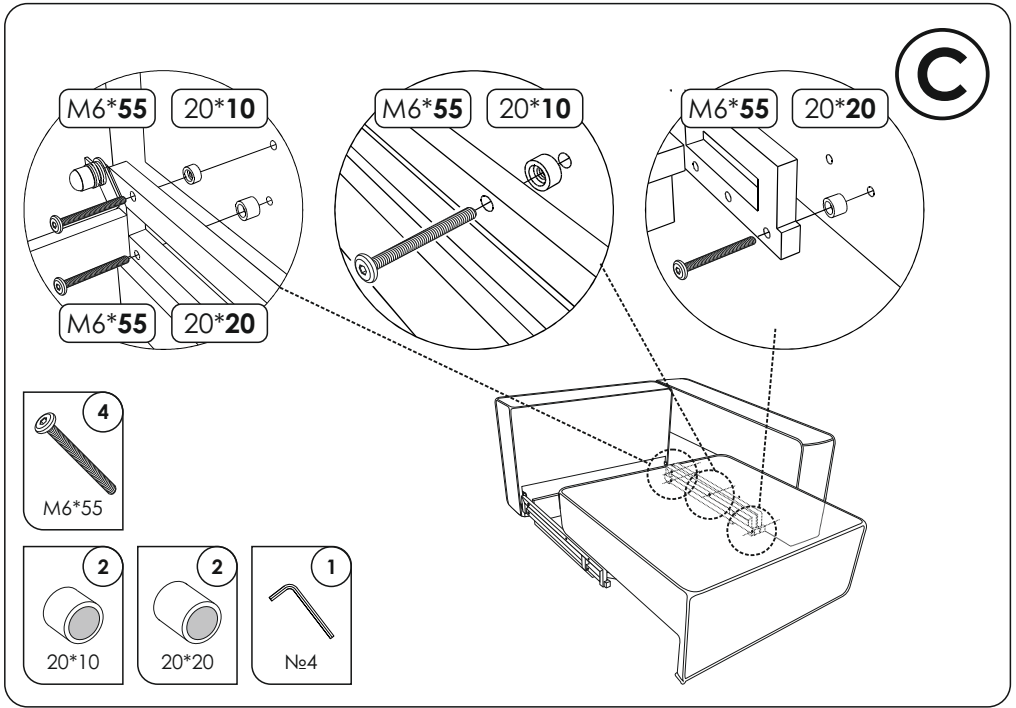

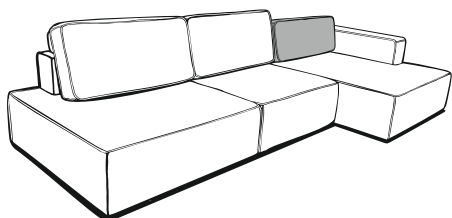

Разгладьте с усилием
Spread with effort

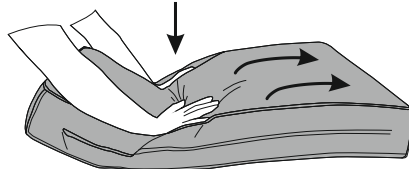

После длительного хранения в упаковке на диванах с канопе возможно различие в размере подушек
After long-term storage in the sofas with canape package the cushions size may be different

Положите под груз минимум на 3 дня
Put under a load for not less than 3 days

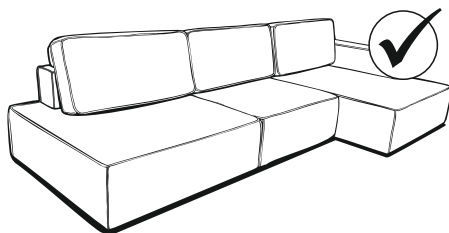
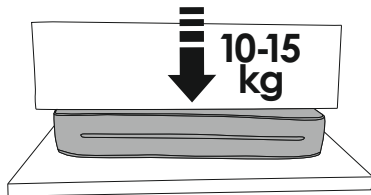

Порядок трансформации дивана Sofa-bed transformation procedure

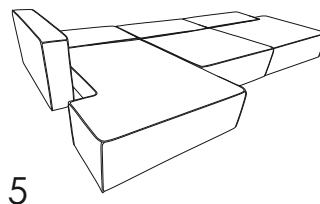
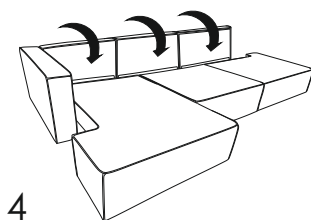
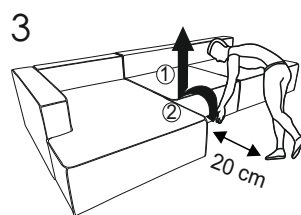
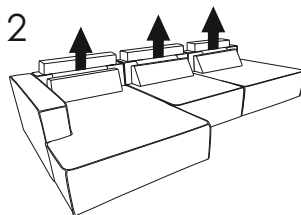
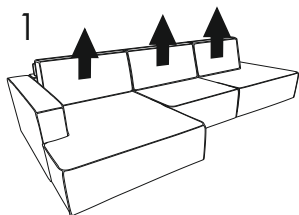

В разложенном положении рекомендуется использовать топпер
Use topper in unfolded state

